



M12 FIR38

SERVICE PARTS DIAGRAM

TTI Model Number: 018 269 009, 010, 017

M12 FUEL™ 3/8" IMPACT RATCHET

Bulletin Date:

Jan-21

Starting Serial Number:

VERSION A - A2018

EXAMPLE:
Component Parts
(Small #) Are Included
When Ordering Assy.
(Large #).

NOTE: Add a drop of
Blue Loctite 243 to
threads of four screws
(21) prior to installing.

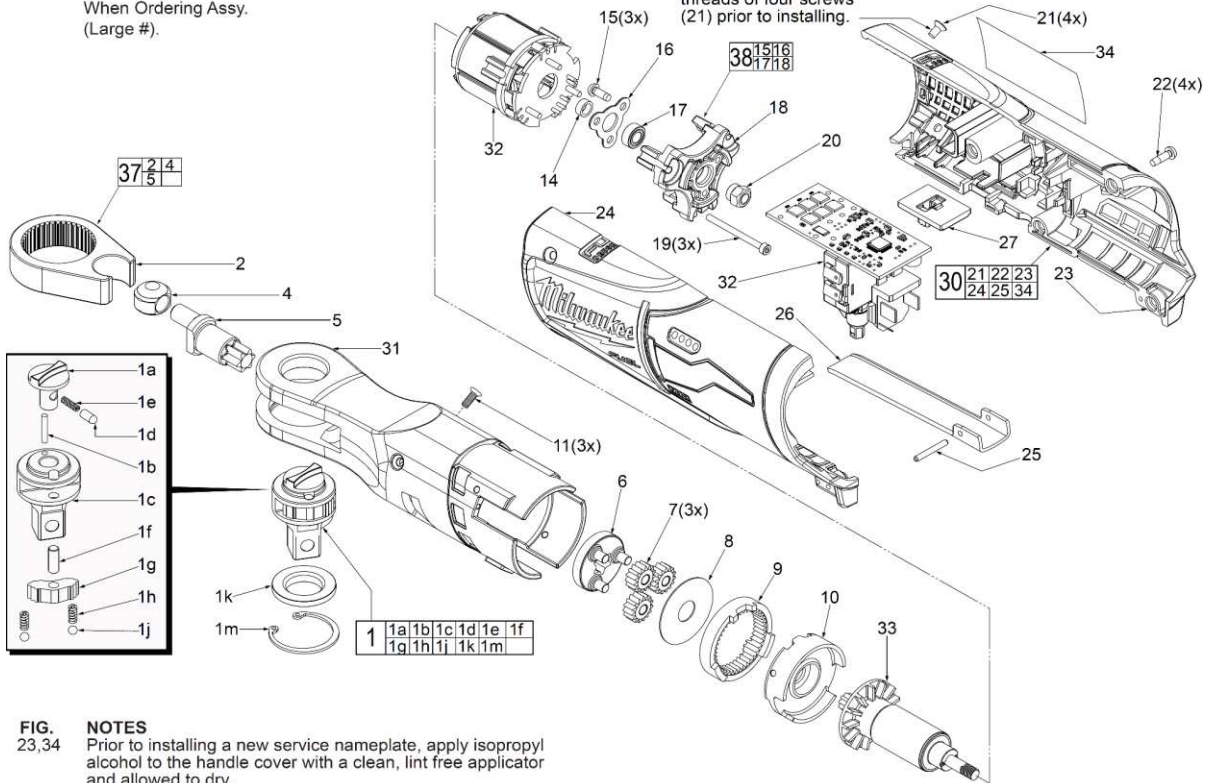
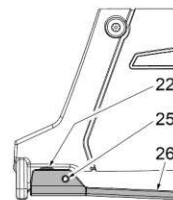

FIG. 23,34 NOTES
Prior to installing a new service nameplate, apply isopropyl alcohol to the handle cover with a clean, lint free applicator and allowed to dry.

25 Use a thin blunt punch with the same OD or a similar tool like a finishing nail with the same OD and the pointed tip ground down to remove spring pin from the handle halves and switch paddle. **As an aid, be sure to prop up that corner end of ratchet to support the tapping out of the spring pin.** When reinstalling pin, align the holes and carefully press or tap the pin in place.

FIG. LUBRICATION (Type 'E' Grease, Item 1200):

- 5** Apply a moderate coating of grease to the small cylindrical surface that goes into driver bushing and to the large cylindrical surface that is surrounded by the two needle bearings.
- 6** Apply a moderate coating of grease to the three axles of the carrier assembly prior to installing the planet gears.
- 8** Apply a light coat of grease to the surface of the washer.
- 9,33** Apply a heavy coating of grease to the inside diameter gear teeth of the ring gear and the teeth of the motor pinion.



NOTE: Spring Pin (25) and Switch Paddle (26) must be removed in order to access Screw (22). See additional note below.





M12 FIR38

SERVICE PARTS LIST

TTI Model Number: 018 269 009, 010, 017

M12 FUEL™ 3/8" IMPACT RATCHET

Bulletin Date:

Jan-21

Starting Serial Number:

VERSION A - A2018

ITEM	PART NUMBER	PART DESCRIPTION	QTY (PCS)
1	204522002	3/8" ANVIL SERVICE KIT	1
1a	613415001	FORWARD/REVERSE KNOB	1
1b	673651001	ROLL PIN	1
1c	622113001	3/8" ANVIL	1
1d	673652001	CAP	1
1e	696060001	SPRING	1
1f	673621001	PAWL PIN	1
1g	695926001	PAWL	1
1h	696279001	SPRING	2
1j	696063001	STEEL BALL	2
1k	696057001	FRICTION PLATE	1
1m	695920001	RETAINING RING	1
2	-	YOKE (FOR 3/8" AND 1/2" RATCHET)	1
4	-	BUSHING (FOR 3/8" AND 1/2" RATCHET)	1
5	-	CRANK SHAFT (FOR 3/8" AND 1/2" RATCHET)	1
6	613249001	CARRIER ASSEMBLY (FOR 3/8" & 1/2" RATCHET)	1
7	613250001	PLANET GEAR (FOR 3/8" & 1/2" RATCHET)	3
8	637796001	WASHER	1
9	613251001	RING GEAR (FOR 3/8" & 1/2" RATCHET)	1
10	613248001	MOTOR HOLDER	1
11	661487001	M3 X 10MM SCREW	3
14	613326001	BUSHING	1
15	-	M3 X 8MM SCREW	3
16	-	BEARING PLATE	1
17	-	BALL BEARING	1
18	-	MOTOR PLATE	1
19	662573001	M2.5 X 31MM SCREW	3
20	696054001	HEX NUT	1
21	662675001	M4 X 6MM SCREW	4
22	660230016	M3 X 10MM SCREW	4
23	-	HOUSING COVER - RIGHT	1
24	-	HOUSING SUPPORT - LEFT	1
25	673021004	SPRING PIN	1
26	633822001	SWITCH PADDLE	1
27	532689001	SWITCH LOCK-OUT	1
30	204525004	HOUSING KIT <i>018269009 ASIA, 010 KR VERSION</i>	1
30	204525019	HOUSING KIT <i>018269017 ONLY JP VERSION</i>	1



M12 FIR38

SERVICE PARTS LIST

TTI Model Number: 018 269 009, 010, 017

M12 FUEL™ 3/8" IMPACT RATCHET

Bulletin Date:

Jan-21

Starting Serial Number:

VERSION A - A2018

ITEM	PART NUMBER	PART DESCRIPTION	QTY (PCS)
31	208308002	3/8" YOKE HOUSING ASSEMBLY	1
32	208303001	ELECTRONICS ASSEMBLY (FOR 1/4" & 3/8" RATCHET)	1
33	208302002	ROTOR ASSEMBLY (FOR 3/8" RATCHET) <i>018269009 ASIA, 010 KR VERSION</i>	1
33	208302006	ROTOR ASSEMBLY (FOR 3/8" RATCHET) <i>018269017 ONLY JP VERSION</i>	1
34	940946801	SERVICE NAMEPLATE <i>018269009 ASIA, 010 KR VERSION</i>	1
34	941050577	SERVICE NAMEPLATE <i>018269017 ONLY JP VERSION</i>	1
35	903307001	ZIPPERED TOOL CASE <i>018269010 KR VERSION</i>	1
37	204522019	YOKE CRANKSHAFT BUSHING KIT	1
38	203721004	MOTOR PLATE ASSY WITH PACKAGING	1
1200	-	TYPE E GREASE	1



M12 FIR38

SERVICE INSTRUCTION

TTI Model Number: 018 269 009, 010, 017

M12 FUEL™ 3/8" IMPACT RATCHET

Bulletin Date:

Jan-21

Starting Serial Number:

VERSION A - A2018

NOTE:

Wires of the electronics assembly (32) are routed in traps and cavities in the right handle half (23).

To replace the Electronics Assembly (32):

Remove four T-10 handle screws (22) from right handle half (23) and two T-10 handle/gear case screws (21) from right handle half.

Gently turn tool over and remove two T-10 handle/gear case screws (21) from left handle half.

Carefully remove the left handle half to expose the electronics assembly.

Use a hex key to remove the three socket head screws (19) and slide stator/rotor/motor mount plate out of yoke housing assembly (31).

Rotor assembly (33) must be removed from the stator by securing the rotor fan and unscrewing the hex nut (20) outside of motor plate (18).

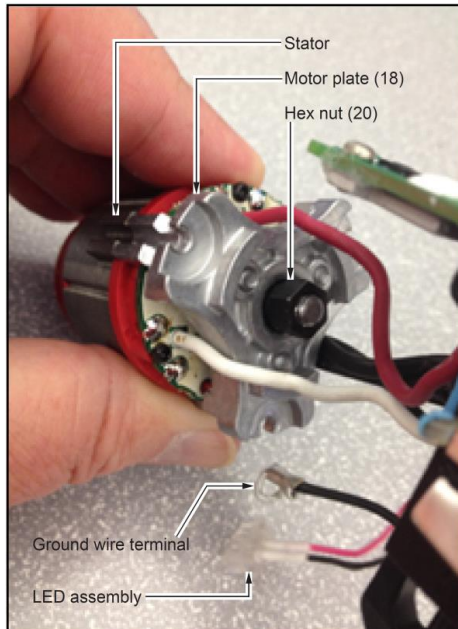
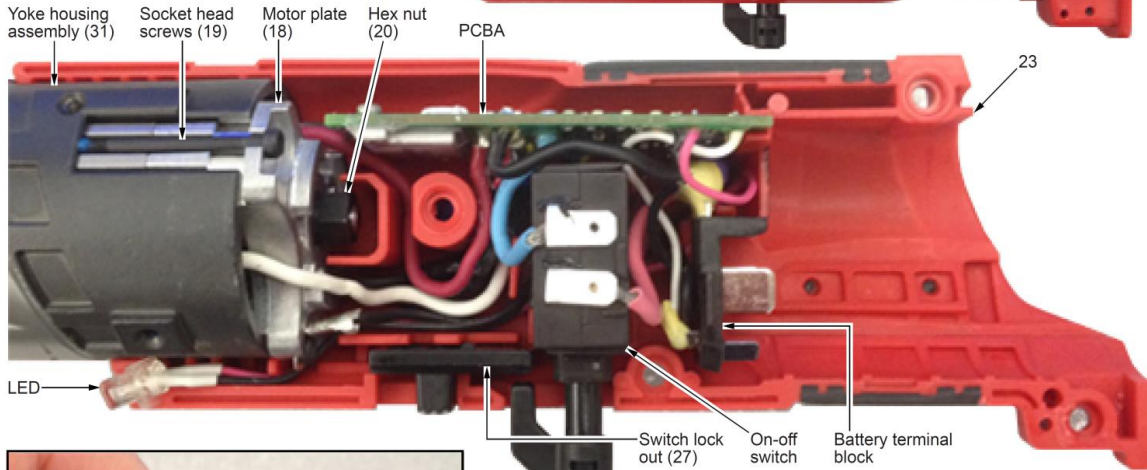
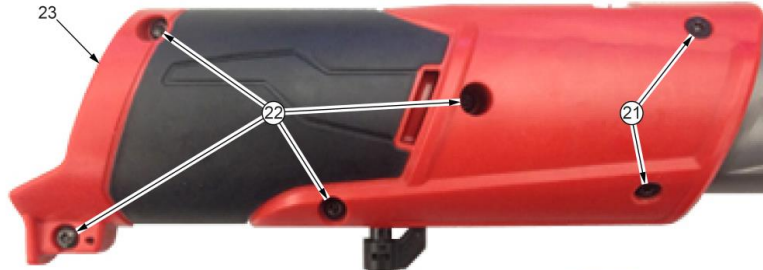

SEE NEXT PAGE FOR SERVICE INSTRUCTIONS TO AID WITH THE REMOVAL AND INSTALLATION OF ELECTRONICS ASSEMBLY (32).



M12 FIR38

SERVICE INSTRUCTION

TTI Model Number: 018 269 009, 010, 017

M12 FUEL™ 3/8" IMPACT RATCHET

Bulletin Date:

Jan-21

Starting Serial Number:

VERSION A - A2018

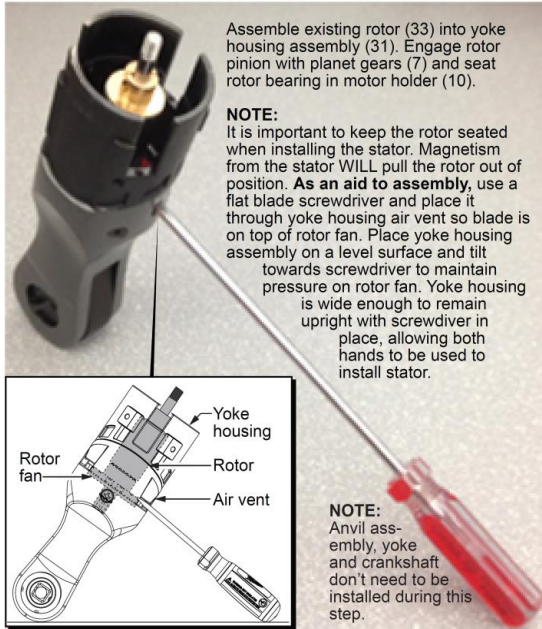

Assemble existing rotor (33) into yoke housing assembly (31). Engage rotor pinion with planet gears (7) and seat rotor bearing in motor holder (10).

NOTE:
It is important to keep the rotor seated when installing the stator. Magnetism from the stator WILL pull the rotor out of position. **As an aid to assembly**, use a flat blade screwdriver and place it through yoke housing air vent so blade is on top of rotor fan. Place yoke housing assembly on a level surface and tilt towards screwdriver to maintain pressure on rotor fan. Yoke housing is wide enough to remain upright with screwdriver in place, allowing both hands to be used to install stator.

NOTE:
Anvil assembly, yoke and crankshaft don't need to be installed during this step.

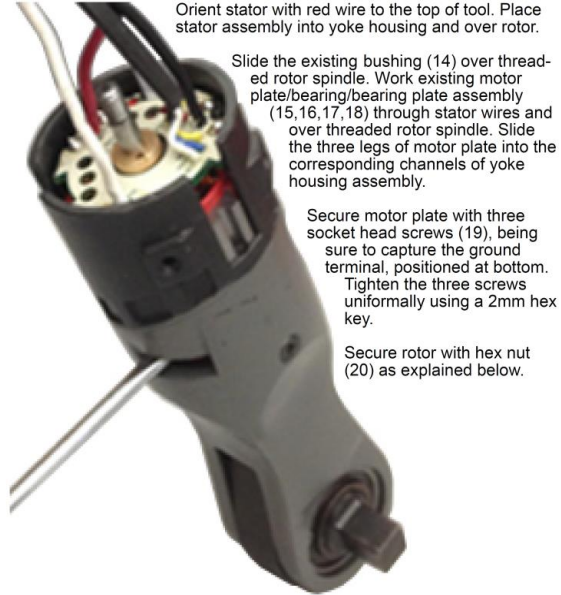

Orient stator with red wire to the top of tool. Place stator assembly into yoke housing and over rotor.

Slide the existing bushing (14) over threaded rotor spindle. Work existing motor plate/bearing/bearing plate assembly (15,16,17,18) through stator wires and over threaded rotor spindle. Slide the three legs of motor plate into the corresponding channels of yoke housing assembly.

Secure motor plate with three socket head screws (19), being sure to capture the ground terminal, positioned at bottom. Tighten the three screws uniformly using a 2mm hex key.

Secure rotor with hex nut (20) as explained below.

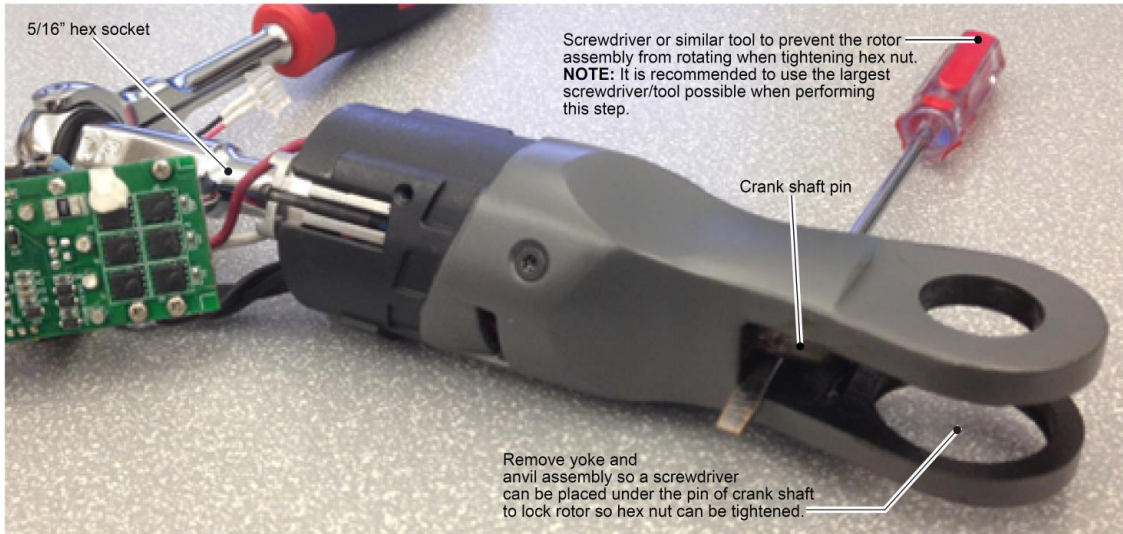

5/16" hex socket

Screwdriver or similar tool to prevent the rotor assembly from rotating when tightening hex nut.
NOTE: It is recommended to use the largest screwdriver/tool possible when performing this step.

Crank shaft pin

Remove yoke and anvil assembly so a screwdriver can be placed under the pin of crank shaft to lock rotor so hex nut can be tightened.

To properly tighten hex nut (20) to rotor (33), it is important to lock rotor and keep it from spinning. The recommended approach is illustrated above.

With a snap ring pliers, remove snap ring (1k). Carefully remove the anvil kit (1) being sure to keep the friction plate (1j) pressed against it. Remove yoke (2) and bushing (4) exposing the 'pin' of crank shaft (5).

With a screwdriver or similar tool, slide under crank shaft pin and wedge between pin and yoke housing, preventing crank shaft and all gearing (including rotor pinion) from moving. Use a 5/16" socket to secure hex nut to rotor spindle. Tighten to 33-37 kg-cm (approx. 28-32 in-lbs).

Remove screwdriver and reinstall bushing and yoke onto crank shaft pin. Carefully place anvil kit and friction plate back into yoke and secure with snap ring.

Place yoke assembly in right handle half. Prior to installing switch and PCBA, place LED assembly in housing half. Route LED wires and ground wire through channels and traps, then behind the switch as shown above. Be sure all wires are pressed down firmly.

Place switch, PCBA and battery terminal block into the handle slots and cavities. Be sure those components are seated firmly and squarely. Pay particular attention that excess wires are tucked behind the battery terminal block and that no wires will interfere with the installation of the other handle half.

Install the switch lock-out slide (27). Carefully place the left handle half (24) onto the right handle half. Be sure the handles fit together properly and secure with screws (21 and 22).

Check for proper functionality of switch and switch lock-out slide. Install battery to make sure tool runs properly.

Install switch paddle (26) and secure with spring pin (25).